

Models of preseismic sliding and slow earthquakes: Implication for precursory phenomena of great interplate earthquakes

Naoyuki Kato

Earthquake Research Institute, University of
Tokyo

Outline

1. Observation of preseismic sliding in the laboratory
2. Laboratory-derived friction law (a rate- and state-dependent friction law)
3. Models for preseismic sliding in the laboratory
4. Models for preseismic sliding of great interplate earthquakes

A example of laboratory rock sample with a pre-cut fault and sensor arrangement [Kato et al., 1992]

The rock sample is bi-axially compressed to generate unstable slip on the pre-existing fault. Shear strain and relative displacement across the fault are measured with sensors along the fault.

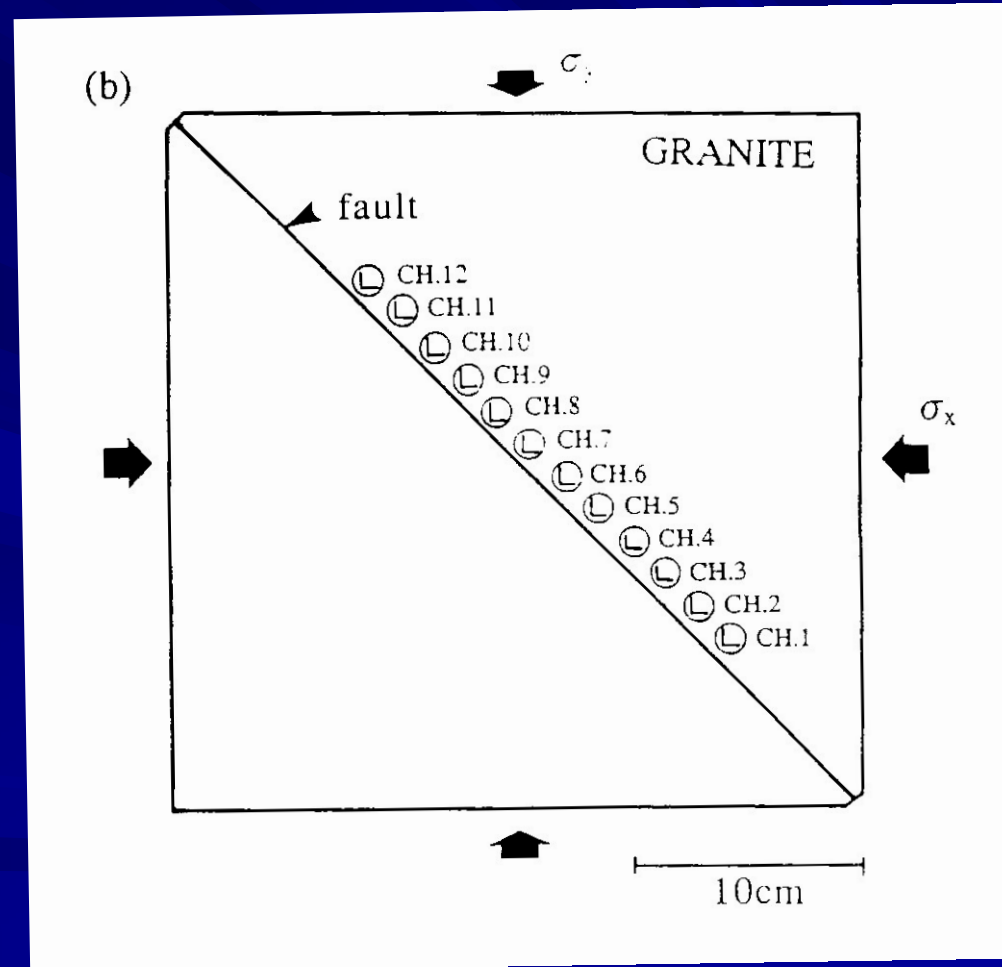

An experimental result of propagating preseismic sliding, the slip nucleation process [Kato et al., 1992]

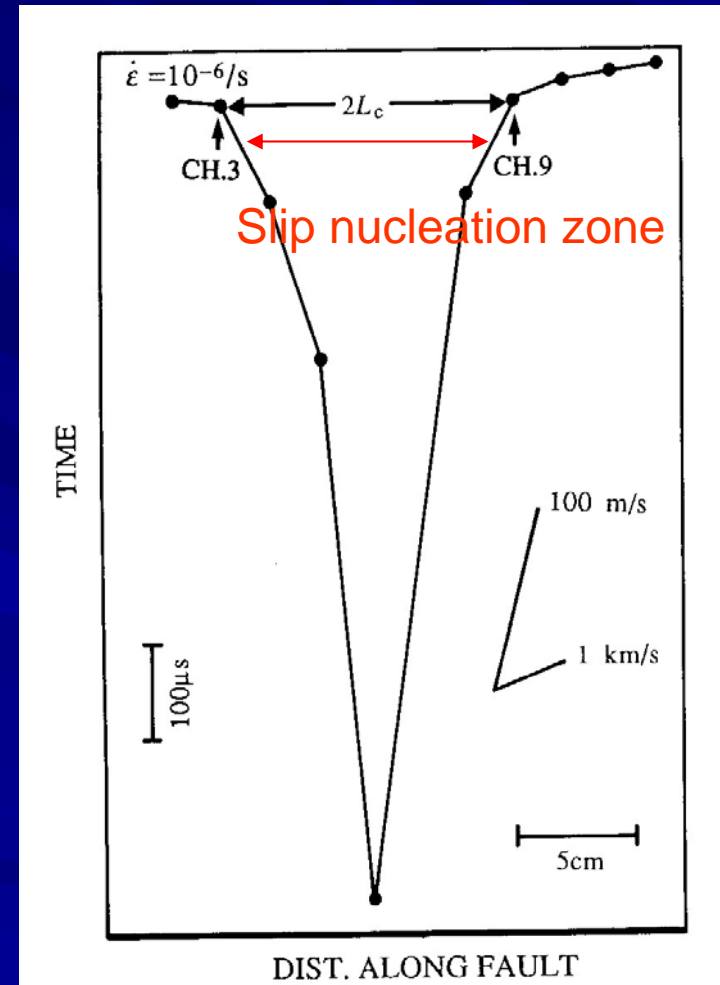
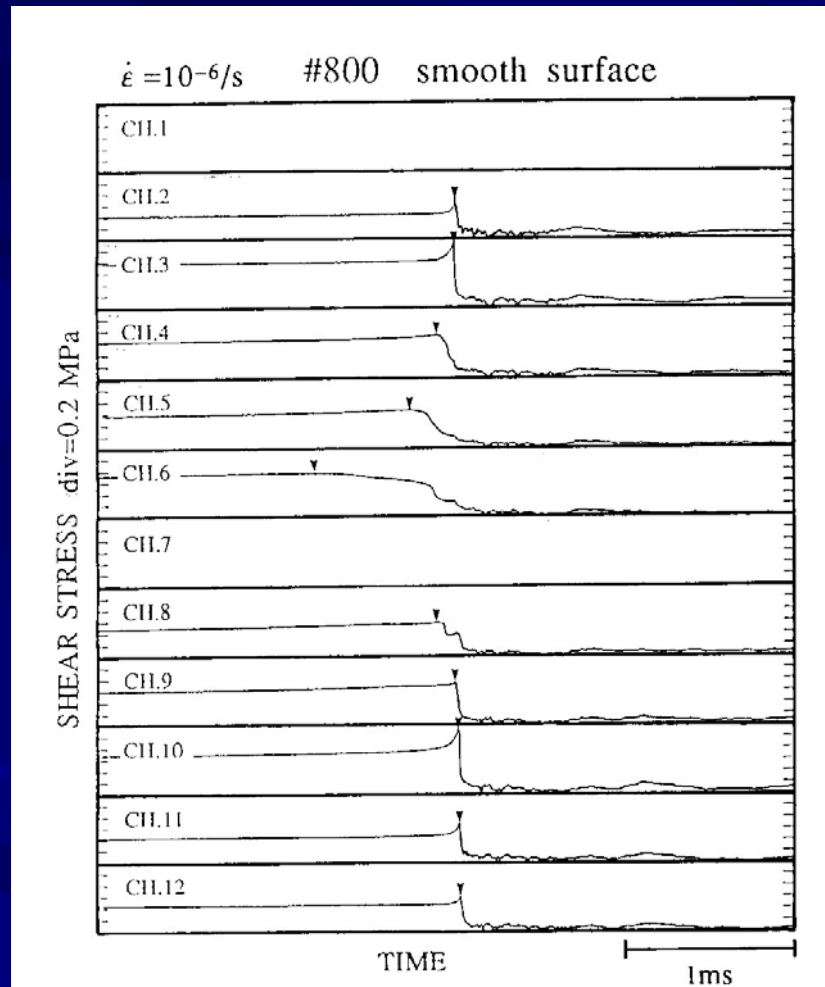

Rate- and state-dependent friction developed by Dieterich (1979) and Ruina (1983)

Friction change at a sudden increase in sliding speed

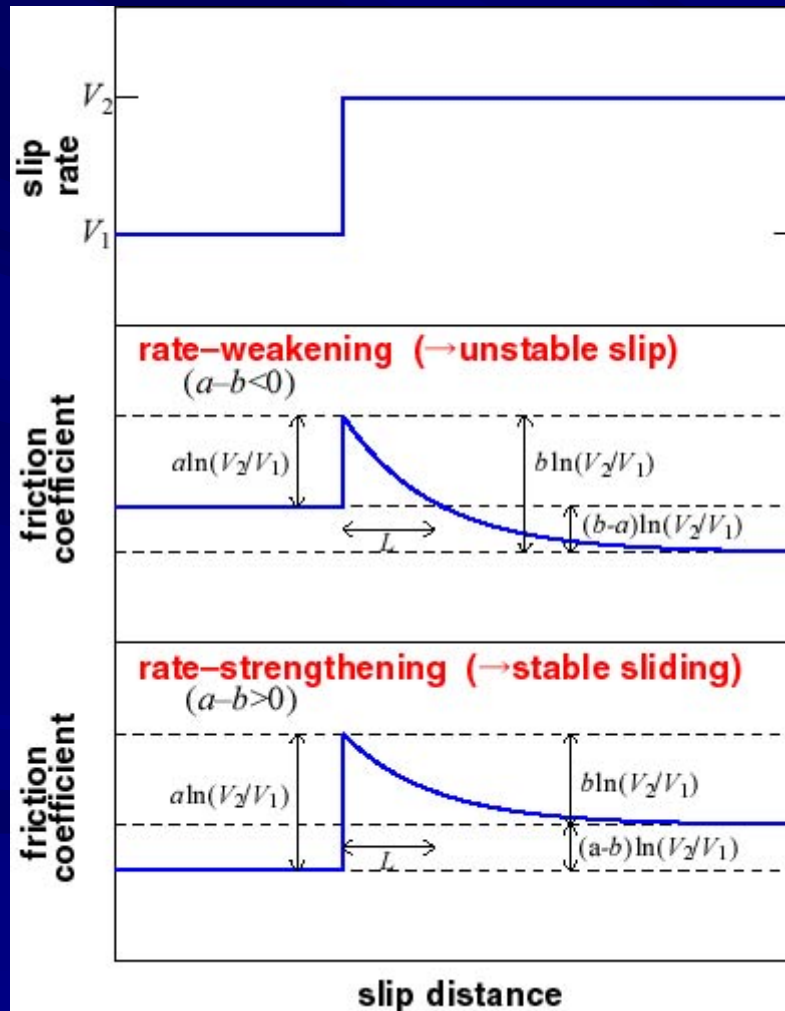

Frictional property is characterized by three constitutive parameters

a, parameter presents velocity-strengthening of frictional stress

b, parameter represents time-dependent restrengthening of frictional stress

L (d_c), parameter represents displacement dependence of frictional stress

Spring-block model for stability analysis of fault motion with a rate- and state-dependent friction

A rigid block is dragged through an elastic spring with stiffness k , where the frictional stress F acts on the base of the block.

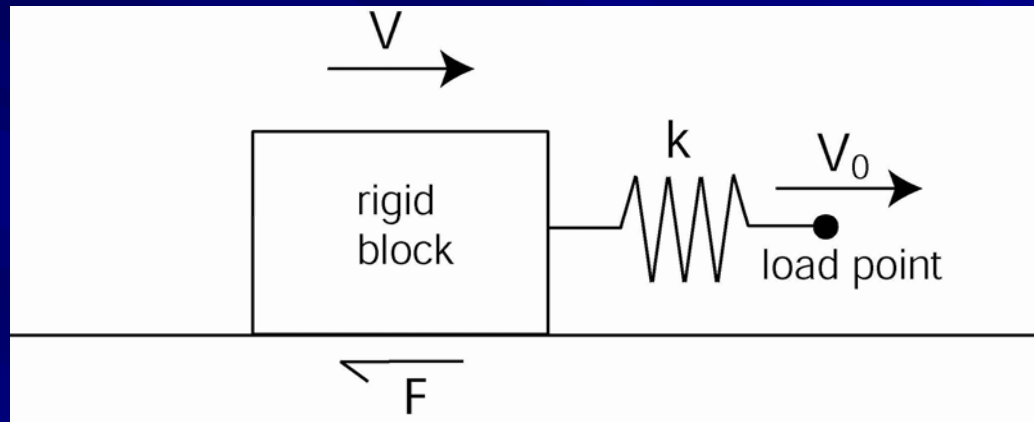

Unstable (seismic) slip occurs for $k < (b-a)\sigma_n/L$, where σ_n is the normal stress.

The critical stiffness k_c is defined by $(b-a)\sigma_n/L$.

Effective stiffness of a fault in an elastic medium may be expressed by the stress change $\Delta\tau$ divided by fault slip Δu : $k_{\text{eff}} = \Delta\tau/\Delta u$.

For a circular fault with a radius of r :

$$k_{\text{eff}} = (7\pi/24)(G/r), \text{ where } G \text{ is rigidity.}$$

When $k_{\text{eff}} = k_c$, the critical fault radius r_c is obtained:

$$r_c = (7\pi/24)[GL/(B-A)], \text{ where } B = b\sigma_n \text{ and } A = a\sigma_n.$$

Preseismic sliding should take place in a finite region (slip nucleation zone) with a radius r_c .

A numerical simulation result of propagating preseismic sliding, the slip nucleation process, with a rate- and state-dependent friction law [Kato and Hirasawa, 1996]

(a) Shear-stress histories

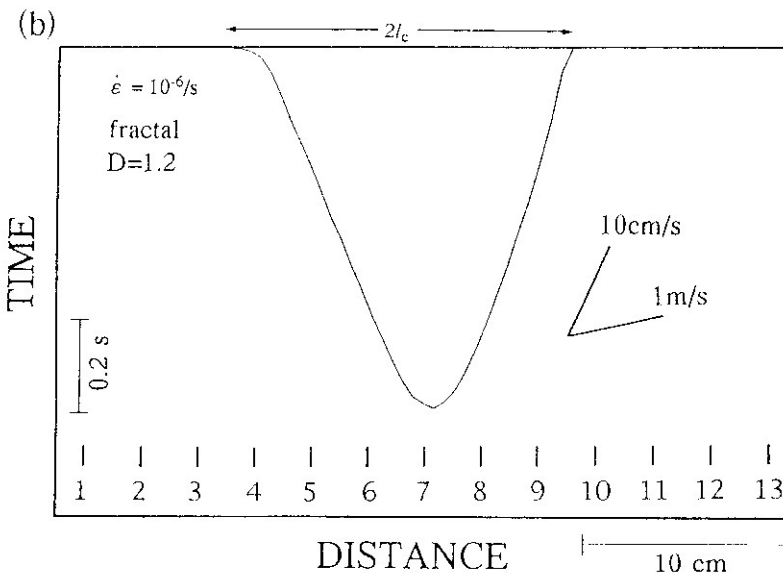
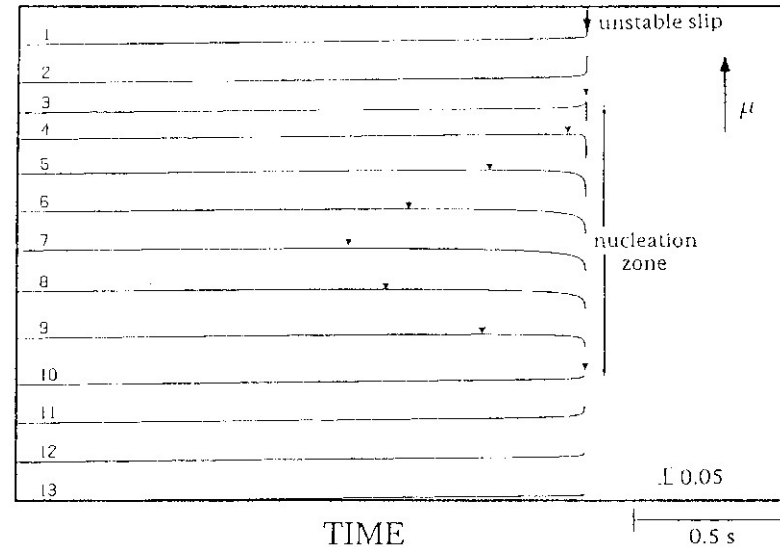

Space-time plot of rupture front

Snapshots of simulated shear stress on the model fault plane: slip nucleation process on a two-dimensional fault plane

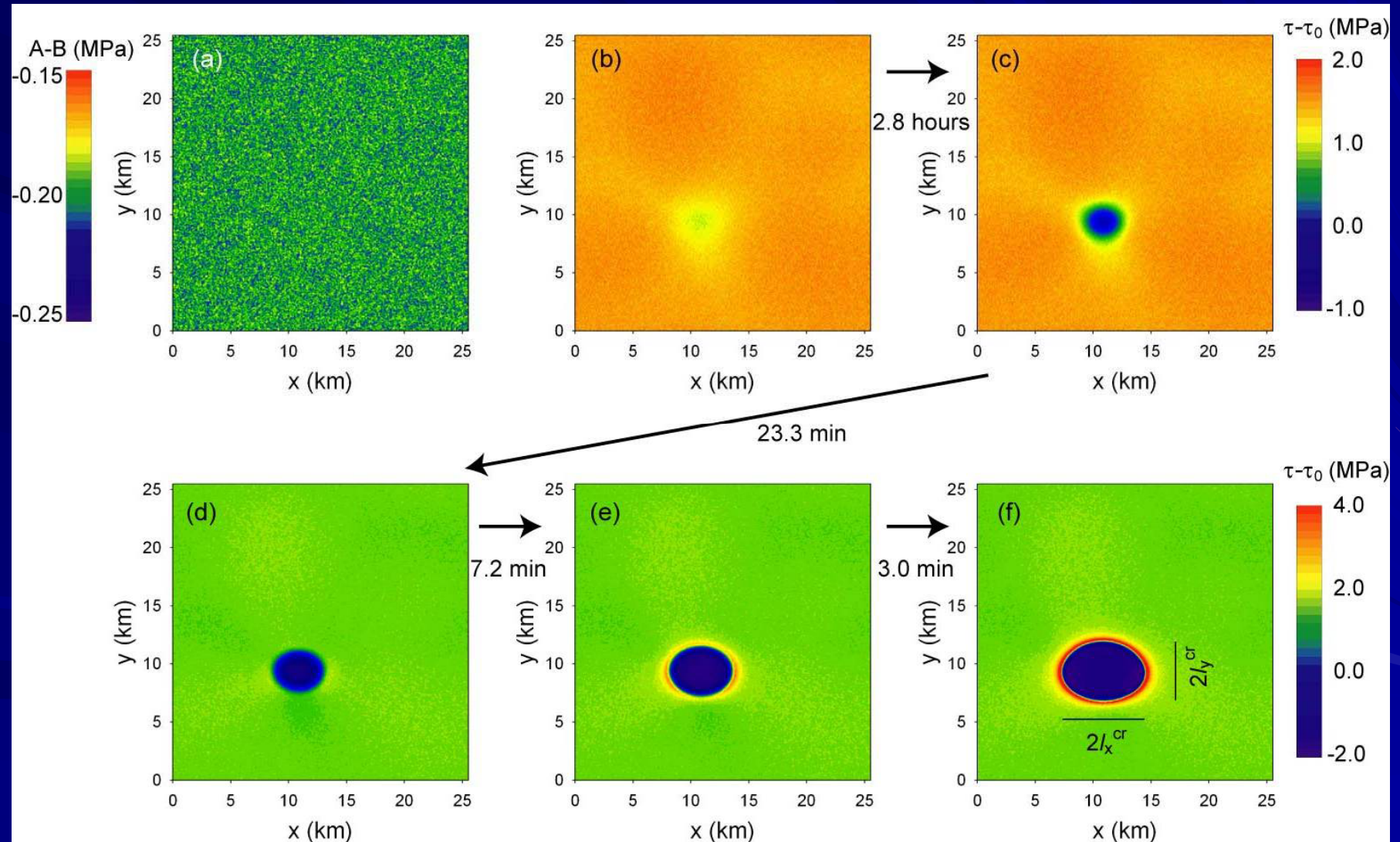

Model for asperity rupture

We consider sliding process on a 2D square fault in an infinite uniform elastic medium.

Frictional stress is assumed to obey a rate- and state-dependent friction law.

We assume nonuniformity in $A-B$ ($=d\tau_{ss}/d\ln V$), which represents rate dependence of steady-state frictional stress τ_{ss} .

Seismic slip may occur for $A-B < 0$ (velocity-weakening friction).

Aseismic slip occurs for $A-B > 0$ (velocity-strengthening friction).

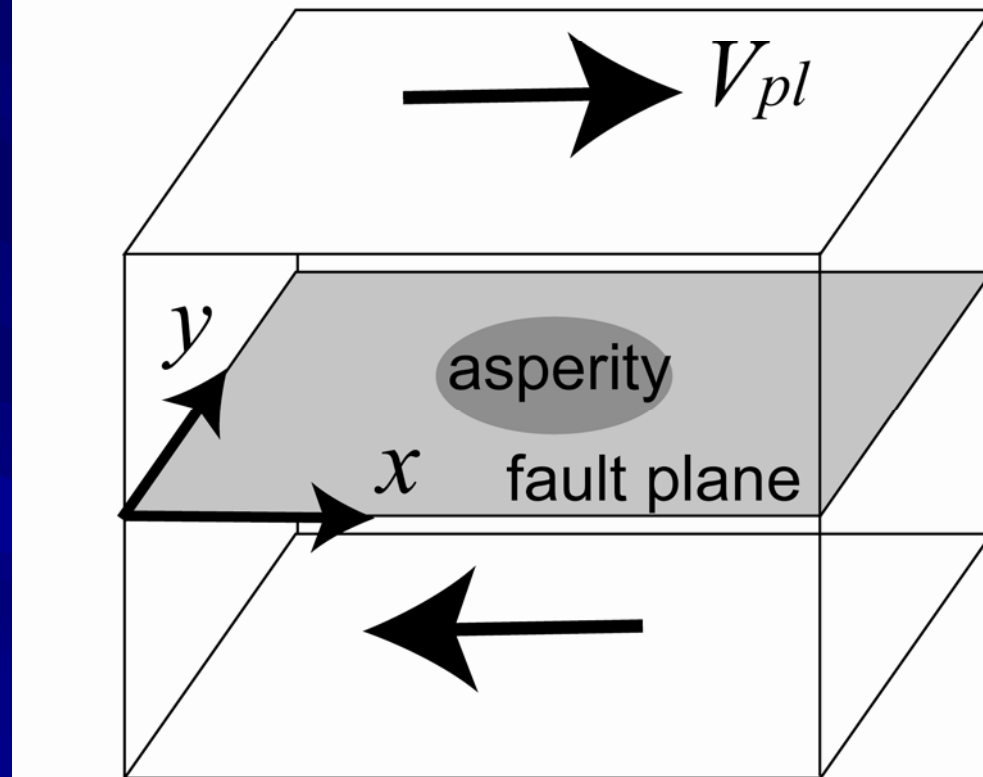

256*256 (=65536) cells.

$V_{pl} = 0.1$ m/yr

Periodic boundary condition

Spatial
distribution of
A-B on a 2D
fault plane

The critical fault
radius $r_c = 1.96$ km

The radius of
velocity-weakening
patch $r = 5.0$ km

$r/r_c = 2.55$

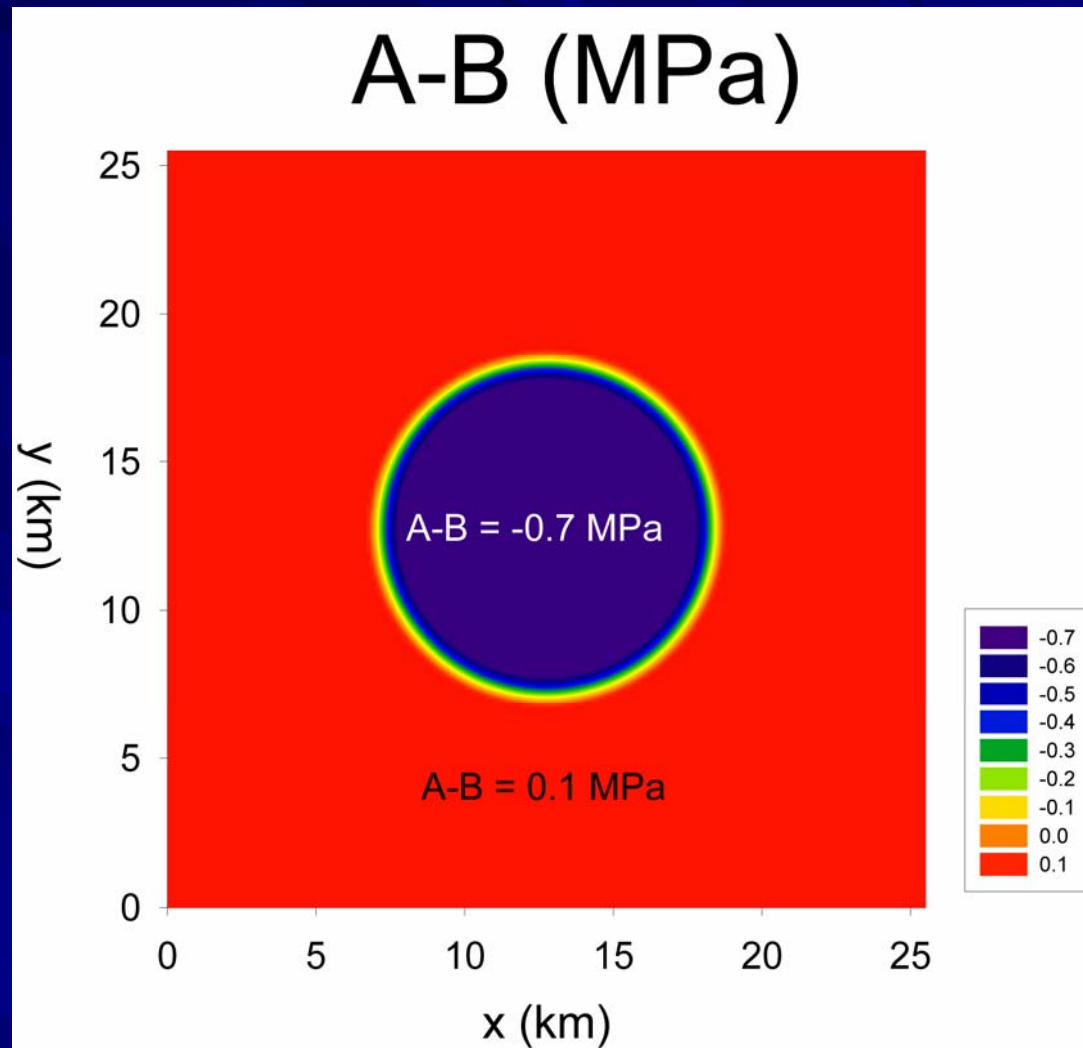

$$r/r_c = 2.55 \text{ (} r, \text{ patch radius, } r_c; \text{ critical patch radius)}$$

Large earthquakes repeatedly occur in the velocity-weakening region at a constant recurrence interval.

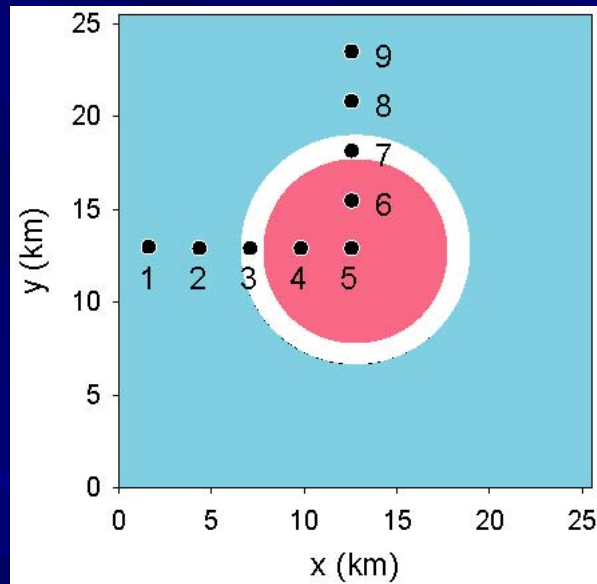

A-B = -0.70 MPa in the velocity-weakening patch

$r_c = 2.0 \text{ km}$

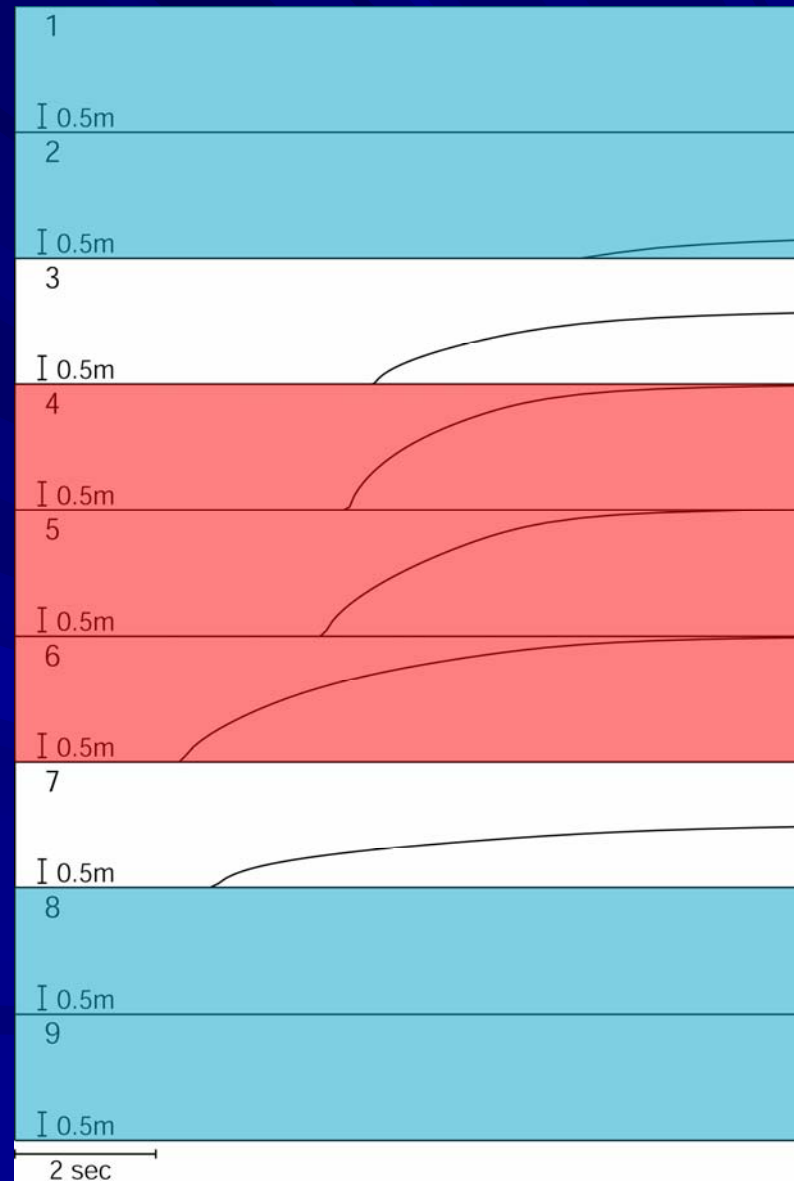

$$r/r_c = 0.51 \text{ (} r, \text{ patch radius, } r_c; \text{ critical patch radius)}$$

Slip duration of a simulated earthquake in this case is about 10 times as long as that for $r/r_c = 2.55$.

Thus is a slow earthquake

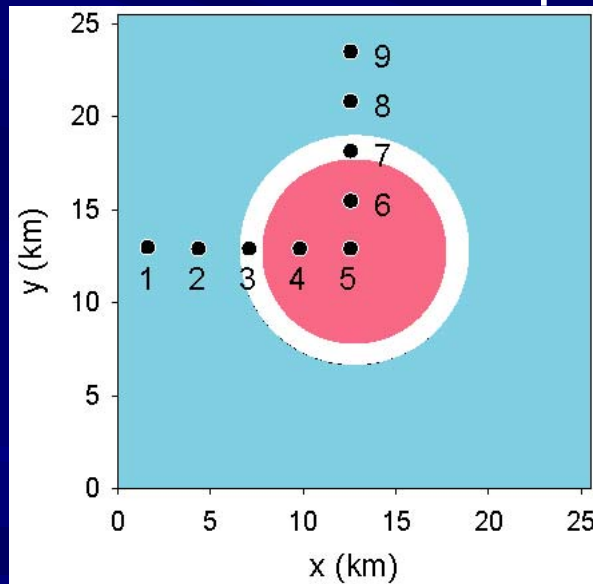

A-B = -0.14 MPa in the velocity-weakening patch

$r_c = 9.8 \text{ km}$

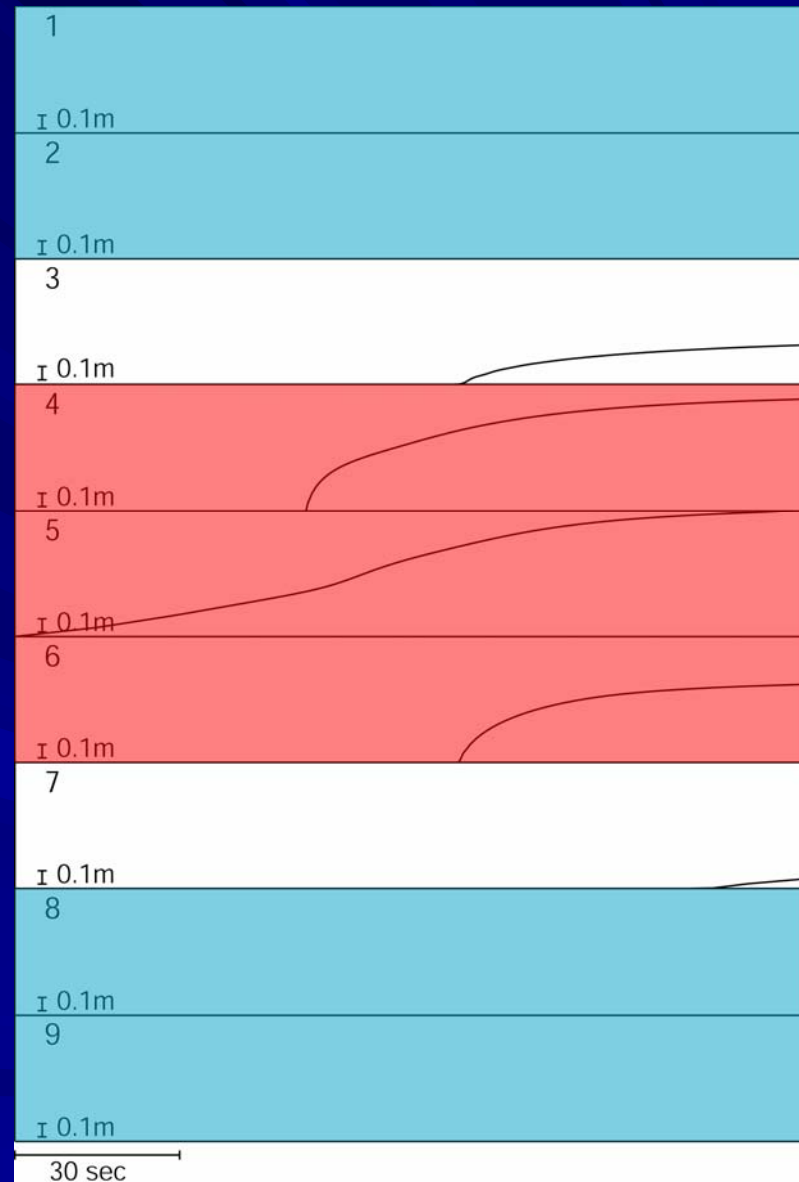

$r/r_c = 0.29$ (r ; patch radius, r_c ; critical patch radius)

Slip duration of a slow earthquake is about 1 year.

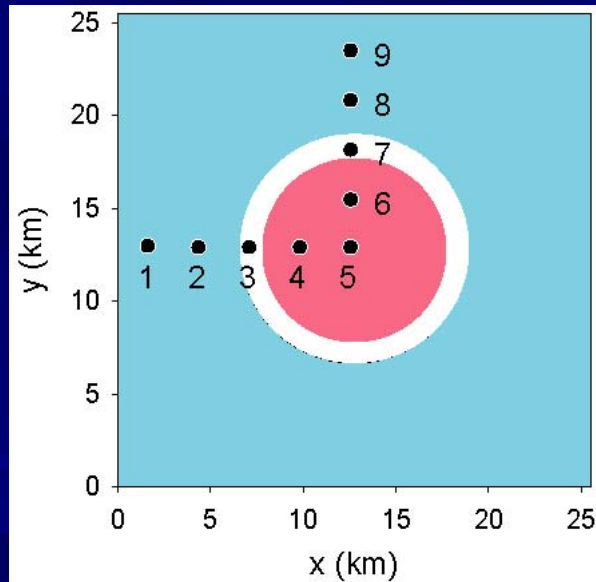

A-B = -0.08 MPa in the velocity-weakening patch

$r_c = 17.2$ km

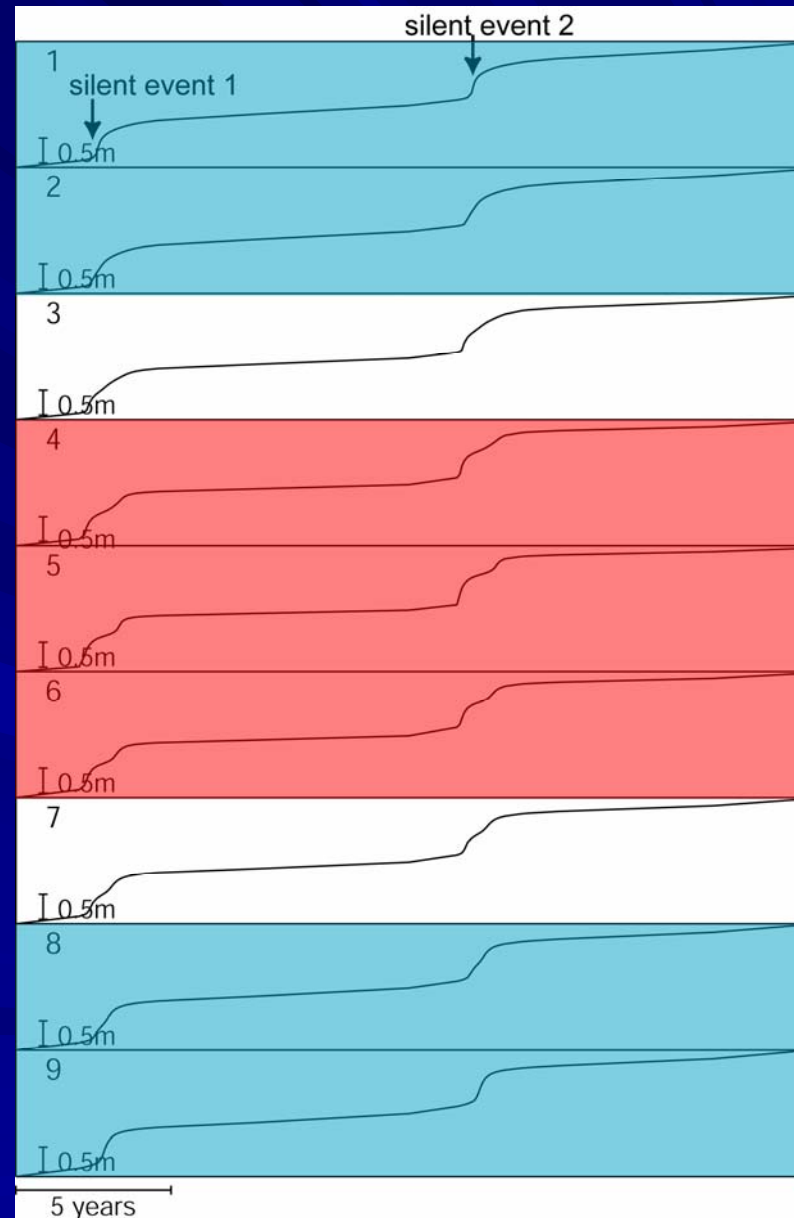

Slip events with various durations may occur dependent on r/r_c [Kato, 2003]

r : the radius of circular patch of velocity-weakening frictional property

r_c : the critical patch size for unstable slip

$$r_c = (7\pi/24)GL/(B-A)$$

G ; rigidity

L ; characteristic slip distance

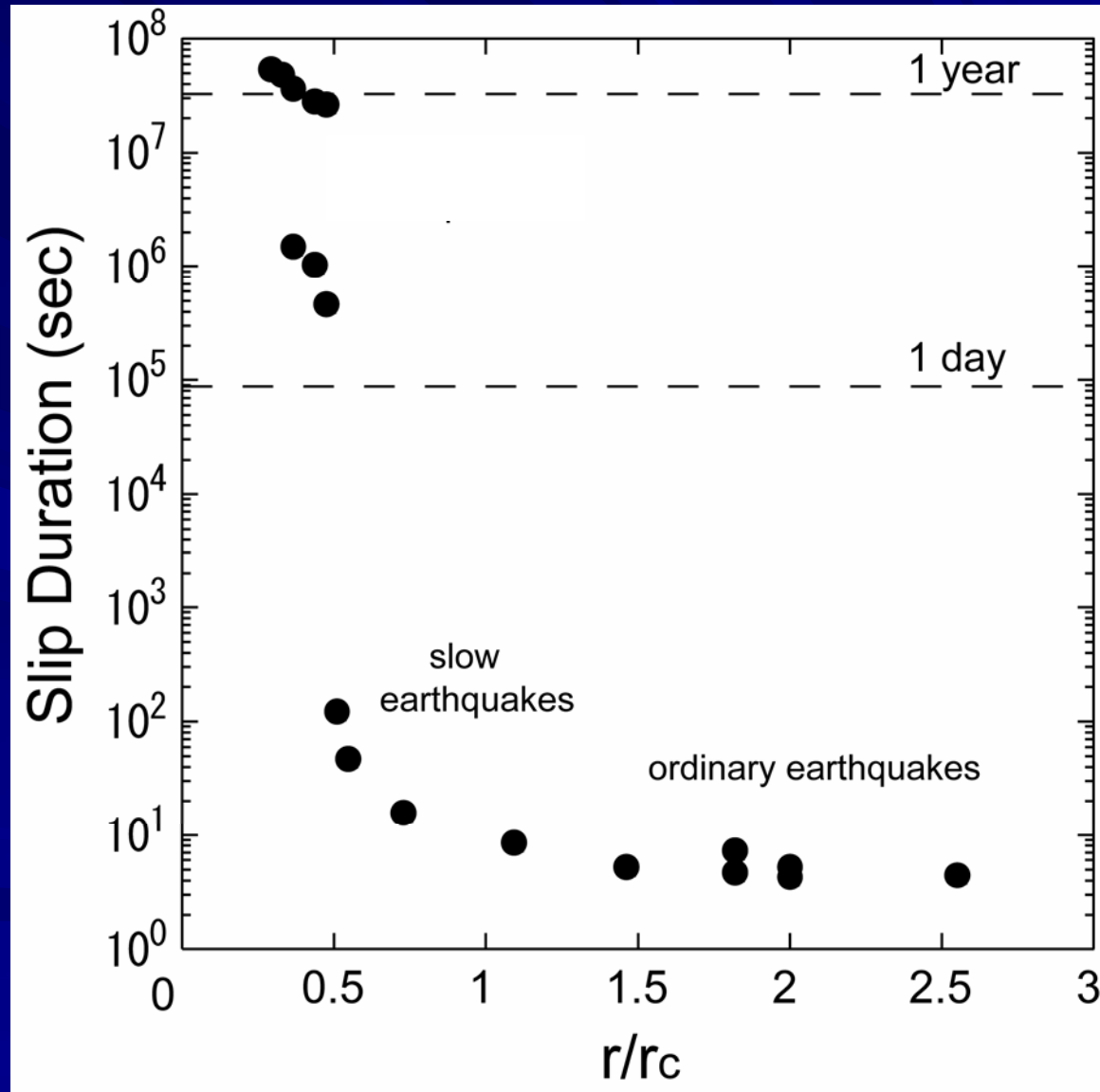

A model for earthquake cycles of large interplate earthquakes in the Suruga trough, central Japan - The Tokai earthquake

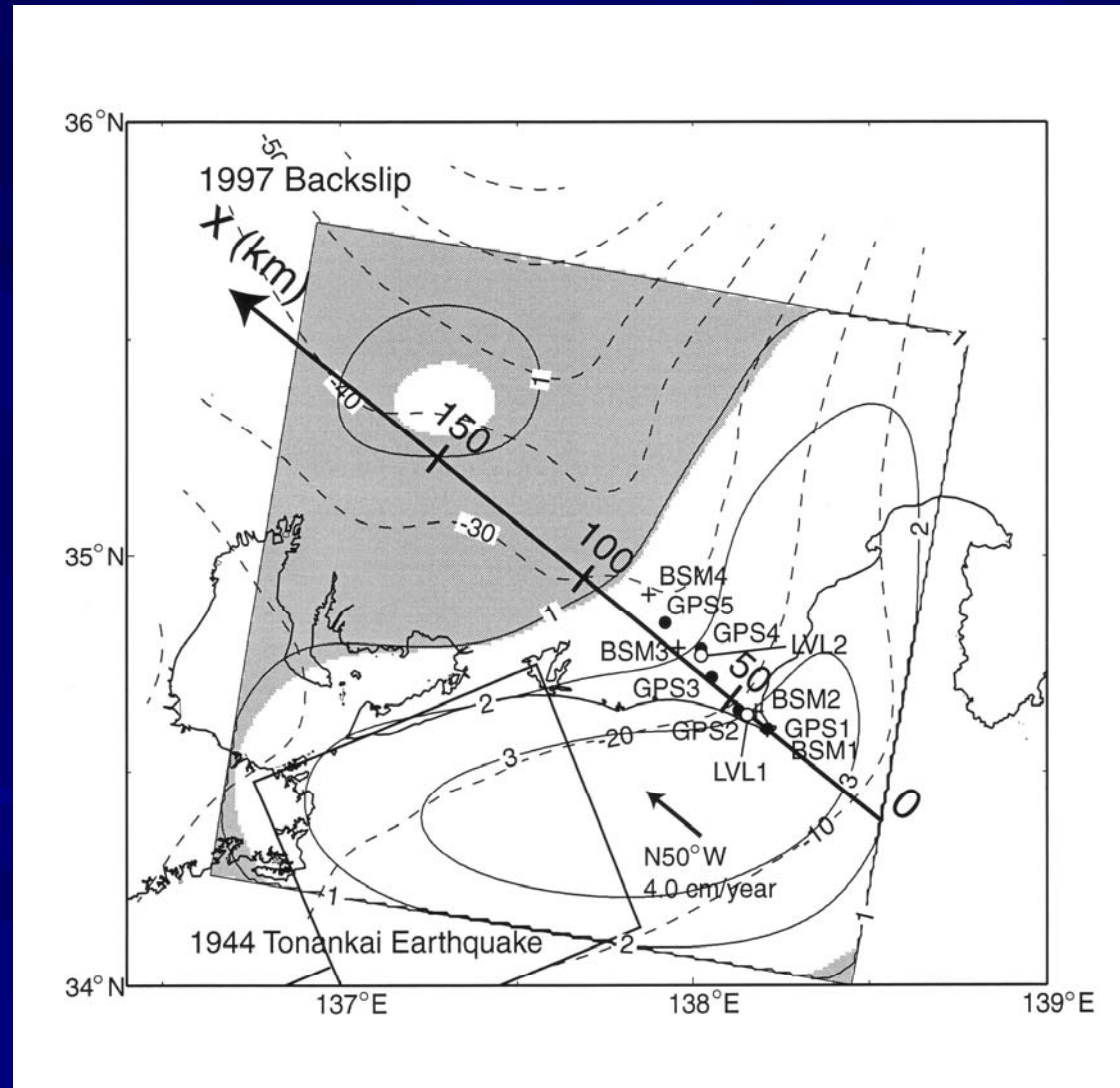

The Philippine Sea plate subducts beneath Honshu.

Large M8 class earthquakes repeatedly occurred along the Suruga and the Nankai trough (e.g., 1944 Tonankai earthquake, 1946 Nankai earthquake).

There is a seismic gap along the Suruga trough, and the Tokai earthquake is expected to occur.

Many observation stations for strain, tilt, ground water level, etc. were set up.

A two-dimensional model for the Tokai earthquake [Kato and Hirasawa, 1999]

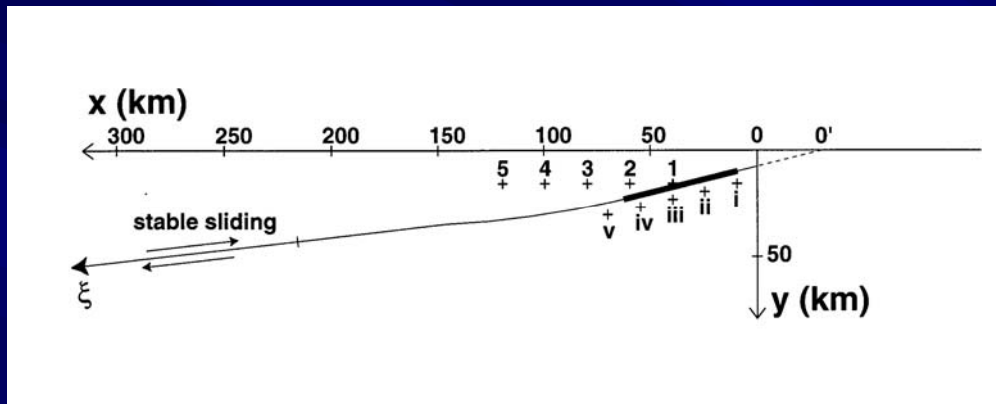

Friction follows a rate- and state-dependent friction law.

Relative plate motion of 4 cm/yr is applied.

Velocity-weakening friction ($a-b < 0$) is assumed at seisogenic depths.

The variation with depth of $a-b$ for the Tokai model

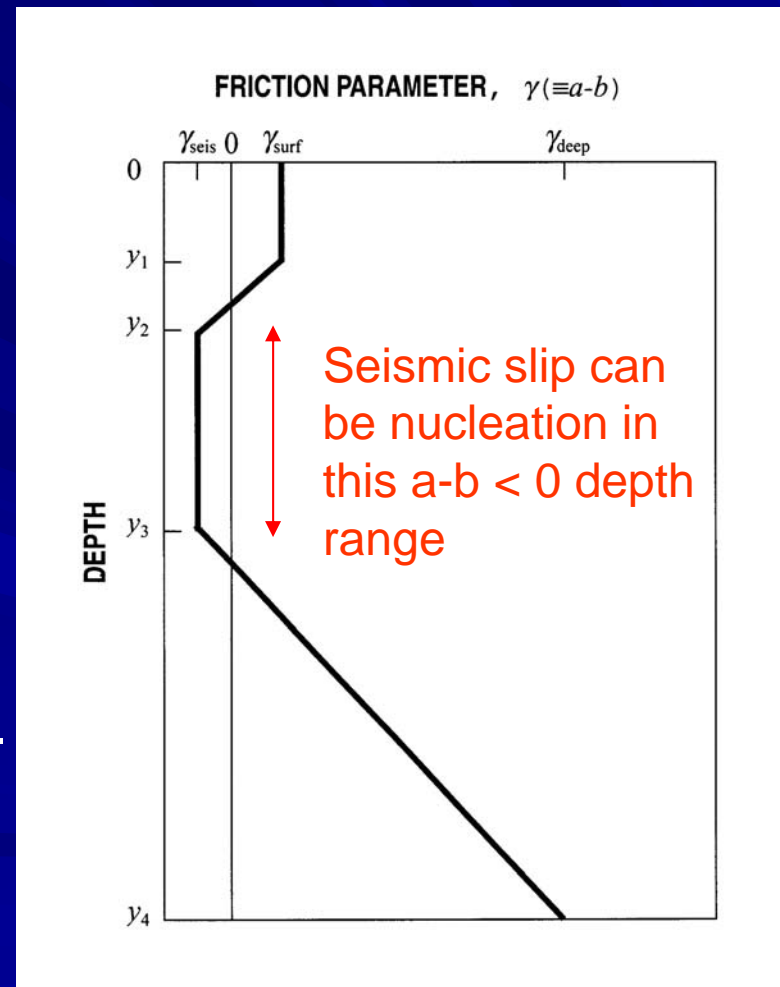

Simulation result of space-time distribution of slip on the plate interface

Friction parameters were determined so that the simulated earthquake cycles would be similar to observations.

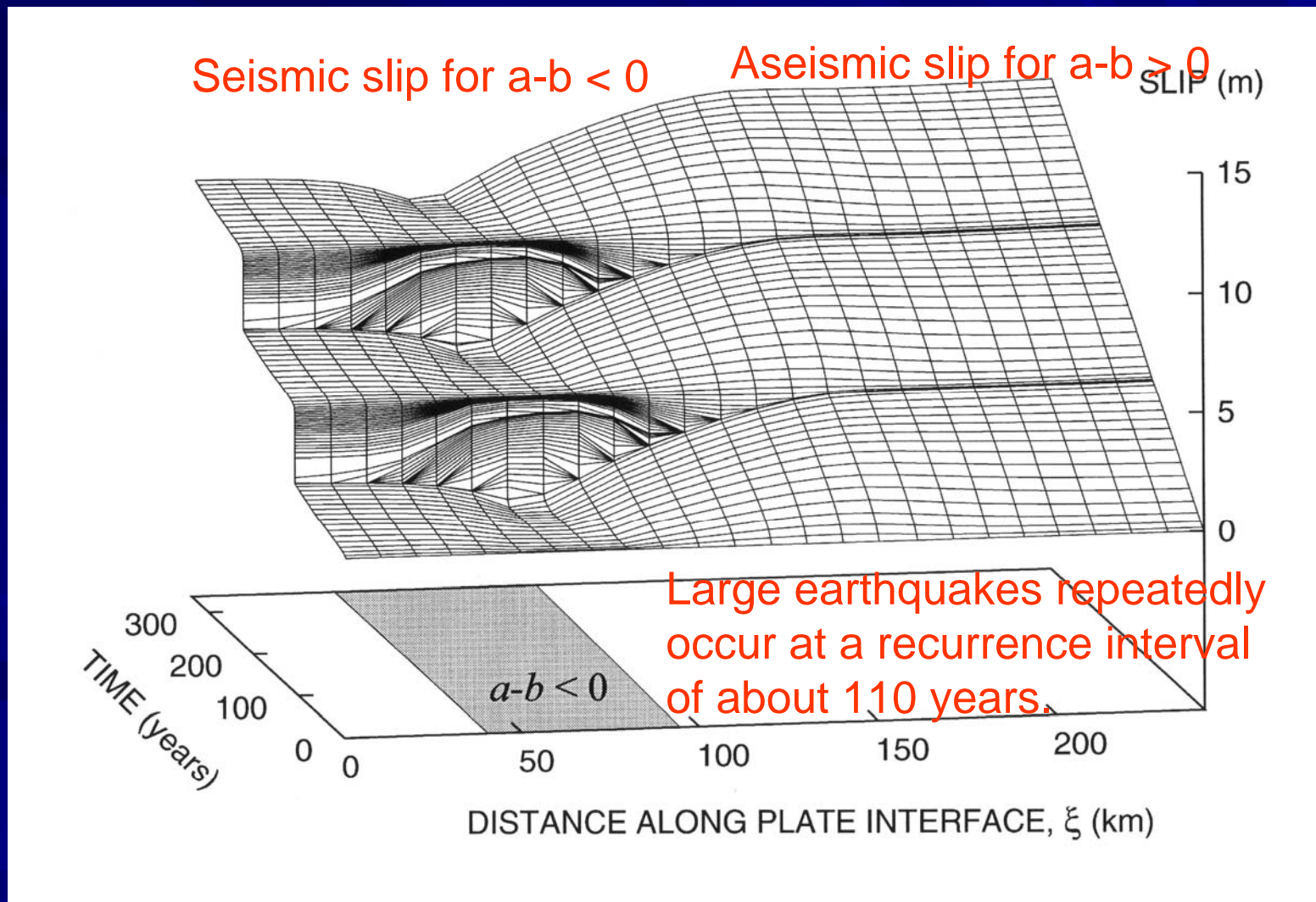

Preseismic sliding for the expected Tokai earthquake in the present model

Crustal deformation (volumetric strain) due to the simulated preseismic sliding

(a) Case 1

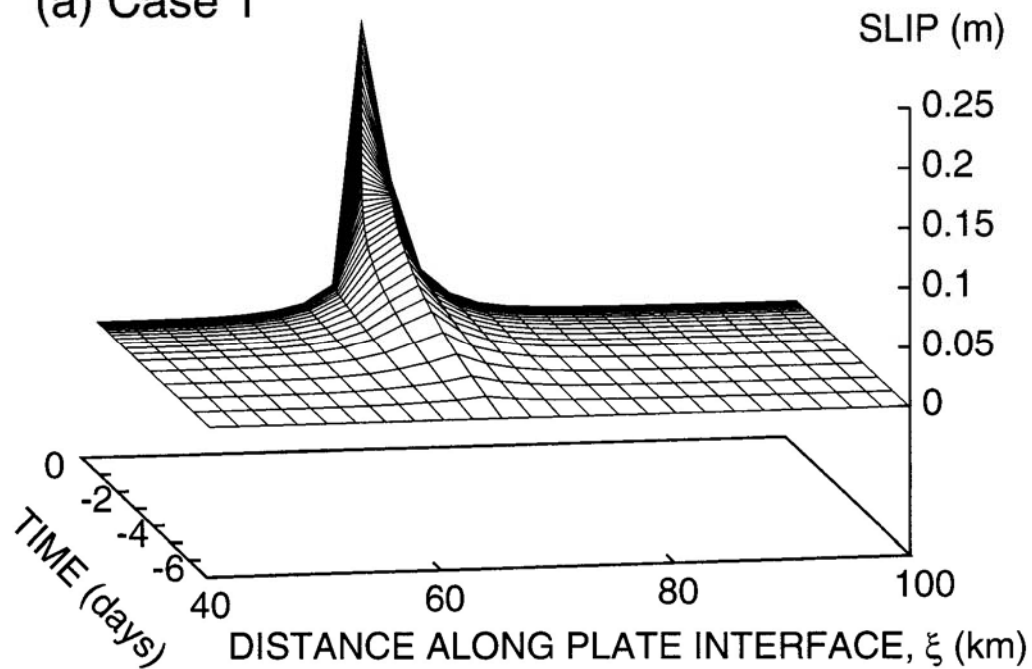

(a) Case 1

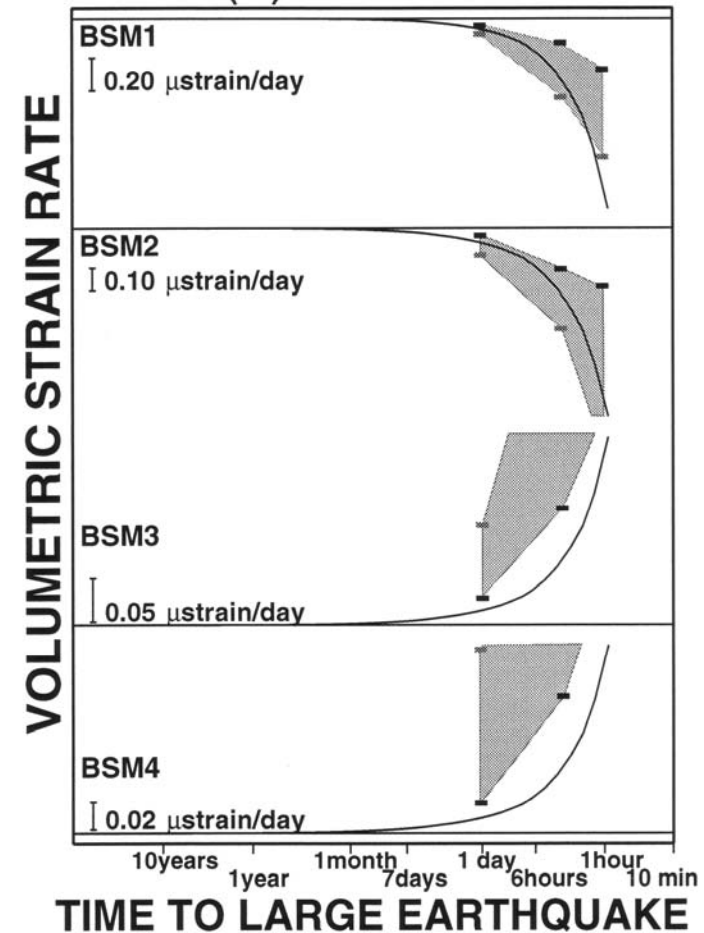

More realistic three-dimensional model for the expected Tokai earthquake was developed by the Japan Meteorological Agency for the purpose of the evaluation of precursory phenomena [e.g., Kuroki et al., 2002]

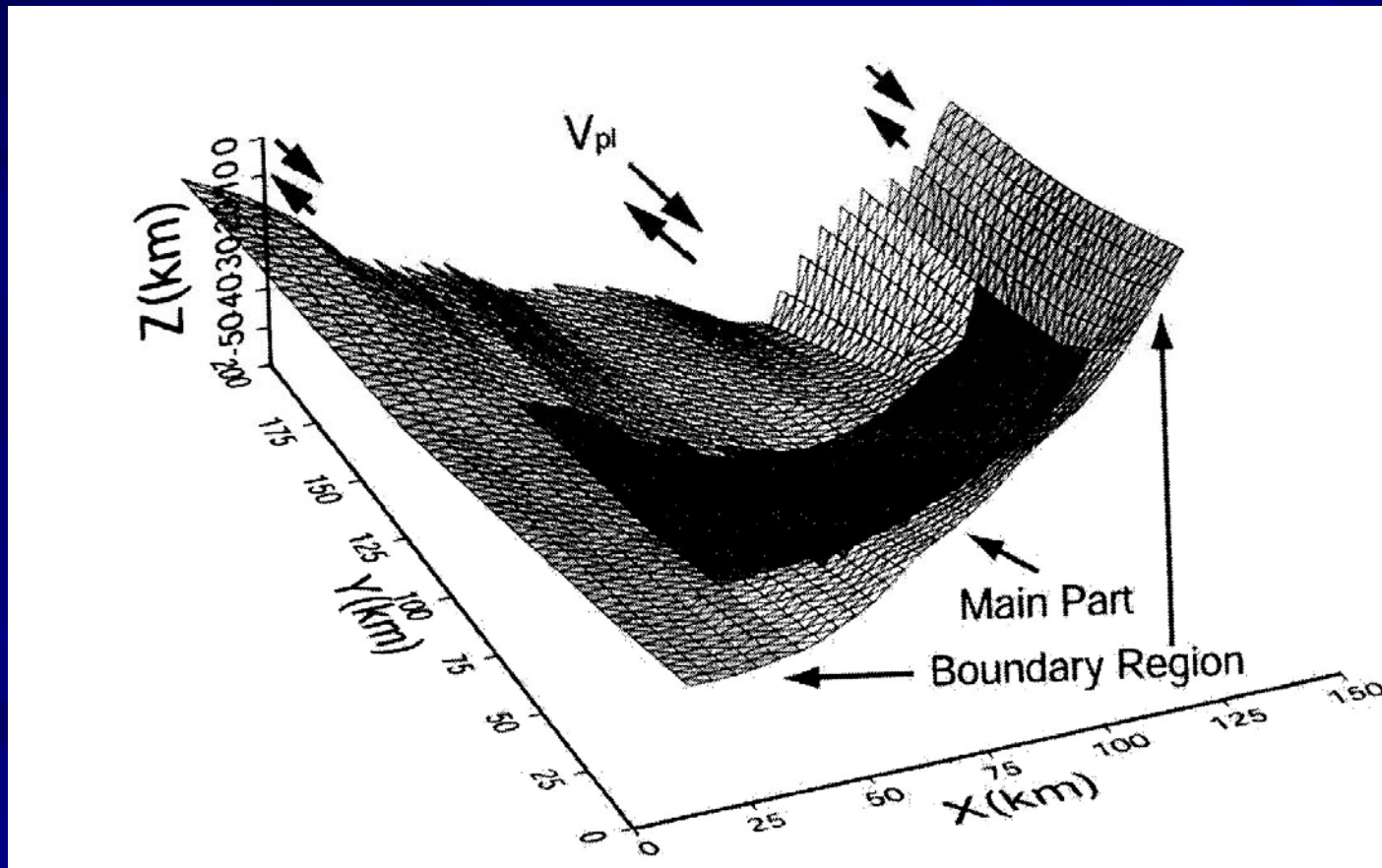

Conclusion

1. Preseismic sliding does occur in the laboratory
2. Characteristics of laboratory observed frictional sliding can be explained by rate- and state-dependent friction laws.
3. The rate- and state-dependent friction well explains preseismic sliding in the laboratory
4. Models for preseismic sliding of great interplate earthquakes have been developed for evaluating possible precursory phenomena. Uncertainty in the amplitudes of preseismic sliding exists mainly due to uncertainty in friction parameters.